

VENTED RELIEF

- 5000 PSI MAXIMUM PRESSURE
- 100-3000 PSI ADJUSTMENT RANGE

PART NUMBER	MAX GPM	CAVITY	SUN NO
RV11A30AL	15	T11-A	RVCA-LAN
RV2A30AL	30	T2-A	RVEA-LAN
RV17A30AL	60	T-17A	RVGA-LAN
RV19A30AL	120	T-19A	RVIA-LAN

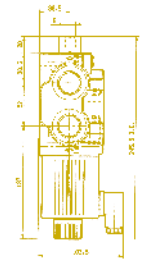
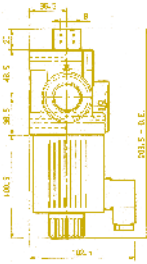
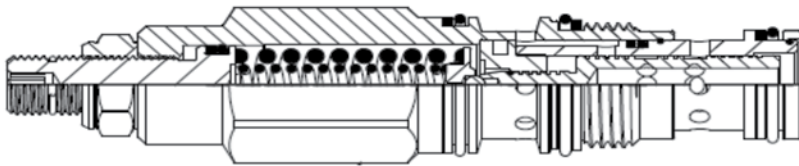
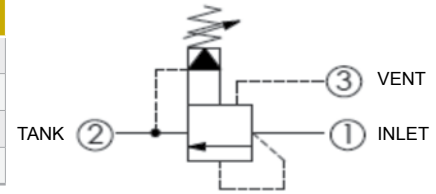

PRESSURE REDUCING

- 5000 PSI MAXIMUM PRESSURE
- 100-3000 PSI ADJUSTMENT RANGE

PART NUMBER	MAX GPM	CAVITY	SUN NO
PB11A30AL	10	T11-A	PBDB-LAN
PB2A30AL	20	T2-A	PBFB-LAN
PB17A30AL	40	T-17A	PBHB-LAN
PBJB-LAN	80	T-19A	PBJB-LAN

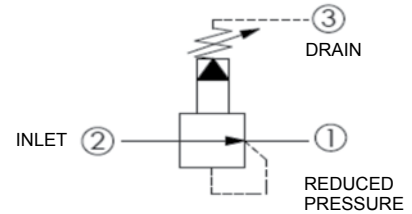

PRESSURE REDUCING / RELIEVING

PART NUMBER	MAX GPM	MAX PSI	PSI RANGE	CAVITY	SUN NO
DF-PRP-00-3000	10	3000	100-3000	C10-3	
SK-PRP-00-3000	20		500-3000	C16-3	
PP11A30AL	10	5000	100-3000	T-11A	PPDB-LAN
PP2A30AL	20			T-2A	PPFB-LAN
PP17A30AL	40			T-17A	PPHB-LAN
PP19A30AL	80			T-19A	PPJB-LAN

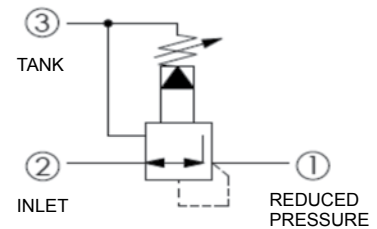

UNLOADING

- 5000 PSI MAXIMUM PRESSURE
- 100-3000 PSI ADJUSTMENT RANGE

PART NUMBER	PSI RANGE	CAVITY
DF-PWE-00-0425	50-425	C10-3
DF-PWE-00-1500	425-1500	

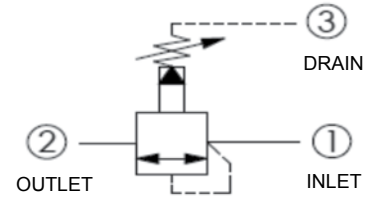

SEQUENCE

- 5000 PSI MAXIMUM PRESSURE
- 100-3000 PSI ADJUSTMENT RANGE

PART NUMBER	MAX GPM	CAVITY	SUN NO
SP11A30AL	15	T-11A	RSDC-LAN
SP2A30AL	30	T-2A	RSFC-LAN
SP17A30AL	60	T-17A	RSHC-LAN
SP19A30AL	120	T-19A	RSJC-LAN

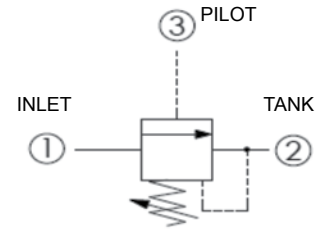

LINE MOUNT BODIES

- MADE IN ALUMINUM
- 3000 PSI MAXIMUM PRESSURE
- DUCTILE IRON AVAILABLE ON DEMAND

PART NUMBER	CAVITY	PORTS 1 & 2	PORT 3	SUN NO	DIMENSIONS						
					A	B	C	D	E	F	HOLES (2)
30102354	C10-3	SAE 08	SAE 08		2.5	2.5	1.5	2.25	0.38	0.28	-
30102576	C16-3	SAE 12	SAE 12		4.0	4.0	2.0	3.38	0.88	-	0.38
11A-S-90-S-8	T-11A	SAE 08	SAE 06	ECJ	3.0	2.75	1.26	2.09	0.38	0.44	0.34
2A-S-90-S-12	T-2A	SAE 12	SAE 06	BCL	3.25	3.0	1.5	2.25	0.5	0.5	0.42
17A-S-90-S-16	T-17A	SAE 16	SAE 06	HCM	4.25	4.0	2.36	2.75	0.75	0.75	
19A-S-90-S-20	T-19A	SAE 20	SAE 06	KCN	5.0	5.0	3.0	4.0	0.5	0.5	

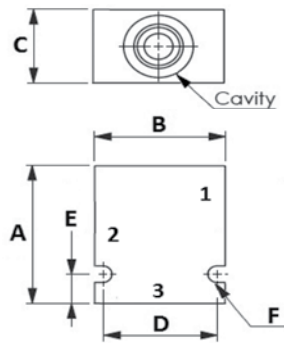

C**-3 BODIES

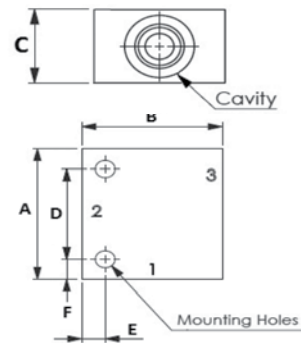

T**A BODIES