

7 TONS-INVERTED TELESCOPIC CYLINDERS

PART NUMBER	CAPACITY	STROKE	OUTSIDE DIAMETER	A	B	C	D	E	F	G	H	I	J	PORT	WEIGHT (LBS)
TC-07833	7 TONS	78"	3.75"	34.62"	7.00"	0.87"	2.00"	1.015"	1.25"	2.25"	1.25"	9.00"	4.25"	1/2 NPT	86
TC-09033		90"	3.75"	38.62"											94
TC-10833		108"	3.75"	44.62"											106

12 TONS-INVERTED TELESCOPIC CYLINDERS

PART NUMBER	CAPACITY	STROKE	OUTSIDE DIAMETER	A	B	C	D	E	F	G	H	I	J	PORT	WEIGHT (LBS)
TC-07843	12 TONS	78"	4.50"	33.87"	7.00"	0.87"	2.00"	1.015"	1.50"	2.25"	1.50"	10.50"	5.00"	1/2 NPT	99
TC-09043		90"	4.50"	37.87"											109
TC-10843		108"	4.50"	43.87"											125
TC-12043		120"	4.50"	47.87"	135										
TC-1204M-S-PT		120"	4.50"	47.87"	137										
TC-1324M-S-PT		132"	4.50"	51.87"	157										
TC-14443M-S-PT	144"	4.50"	55.87"	171											

RETRACTED TOLERANCE ± 1/8"

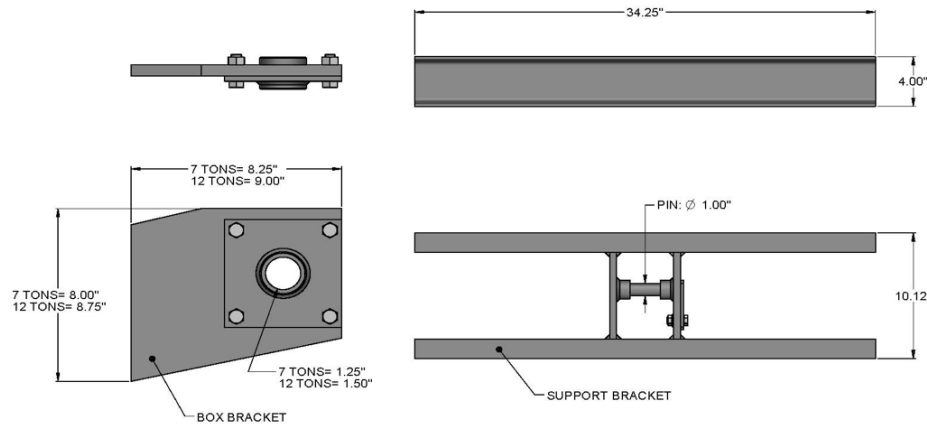

TELESCOPIC ACCESSORIES	
PART NUMBER	DESCRIPTION
TC-SB	BRACKET FOR 7 AND 12 TONS
TC-S07-PAIR	BOX BRACKET KIT 7 TONS
TC-S12-PAIR	BOX BRACKET KIT 12 TONS

HYDRO CUSTOM IS NOT RESPONSIBLE FOR INCORRECT RESULTS OBTAINED WITH FIGURES IN THIS DOCUMENT. INFORMATION IS FOR REFERENCE ONLY. NO OTHER CONDITIONS ARE EXPRESSED OR IMPLIED.